

Powerline

X2R Red Crossline Laser



INSTRUCTION MANUAL

SAFETY

Please read this instruction manual before operating this product.
Please store this instruction manual in the carry case for future reference.

CAUTION: Class 2 Laser Product

Do not stare directly into the laser beam from apertures.
Do not disassemble the instrument or attempt to perform any internal servicing as this will void your warranty. No user serviceable parts included.
Only approved and authorised service technicians can carry out warranty repairs.

ITEM CHECKLIST

Please ensure the following items are included with your laser.
If anything is missing please contact your retailer.

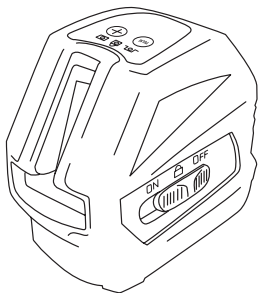

Powerline X2R



Laser target

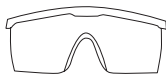

Laser glasses

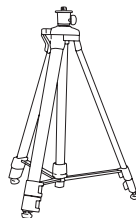

Indoor tripod



Levelling base

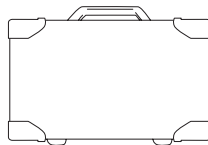

Carry case



Batteries

PRODUCT OVERVIEW

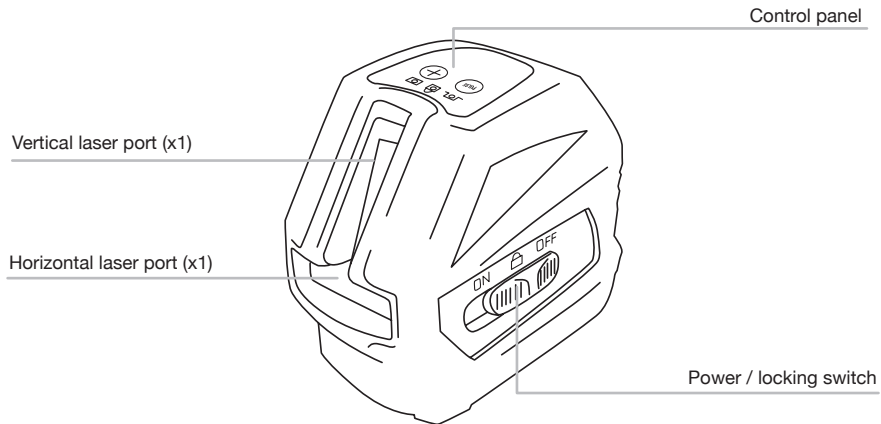

CONTROL PANEL

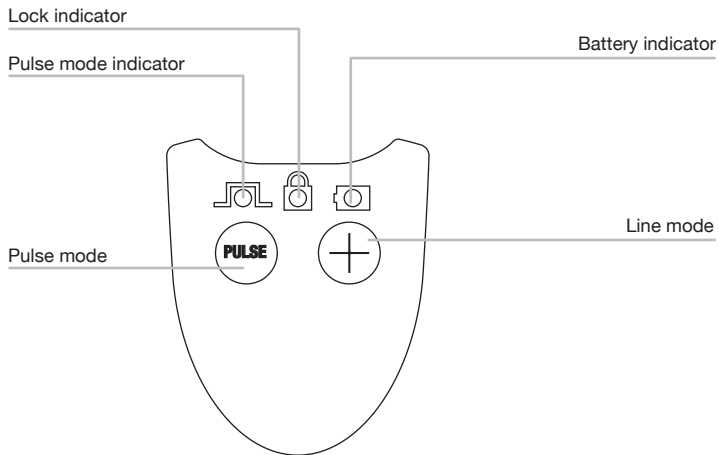

DETECTOR CONTROL PANEL*

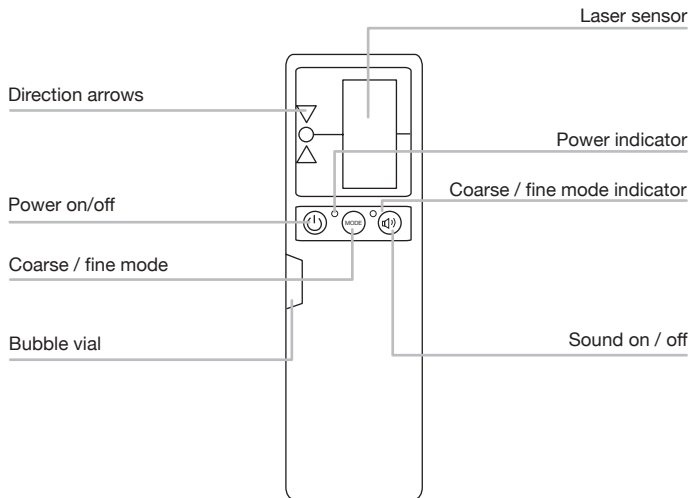

*The detector is an additional accessory which can be purchased from your retailer.

USING YOUR LASER

Power Supply

- The X2R is powered by three AA alkaline batteries.

Setting Up

- Select a place as close as practical to the work site.
Ensure the location is clear of traffic.
- Place the laser on a level surface such as a bench or mount.

Operation

- To turn the unit on slide the *power* switch to “on” position.
Self levelling will commence and the beams will appear.
- If the unit is outside the self levelling range the unit will not level causing the speaker to beep and the laser beam to flash repeatedly.
- Press the *line mode* button on the control panel to cycle through the active beams.

Using the levelling base

- ▶ Unscrew the laser adapter from the centre of the levelling base.
- ▶ Screw the laser adapter into the base of the unit until firm.
- ▶ Insert the laser adapter into the levelling base and push forward to secure into place.
- ▶ For storage, follow the steps in reverse order.

1

laser adapter

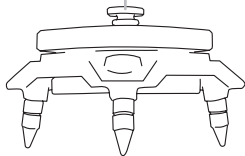

2

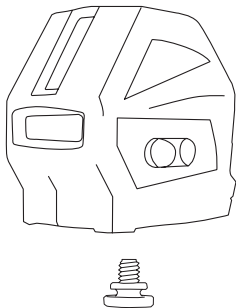

3

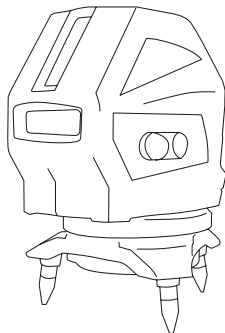

Using Your Detector*

- ▶ Press the *pulse* button on the control panel on top of the laser to enter into pulse mode.
- ▶ Switch the detector on and move it into the path of the laser beam.
- ▶ Hold the detector upright for horizontal beams. Rotate the detector 90° for vertical beams. The direction arrows will indicate the position of the laser beam. The centre LED will indicate alignment with the beam.



*The detector is an additional accessory which can be purchased from your retailer.

CARE AND MAINTENANCE

- ▶ This is a precision instrument and should always be transported within the carry case provided.
- ▶ Always turn the on/off lock to “off” when transporting the unit.
- ▶ Whenever possible, store the instrument in a dry, shady location.
- ▶ The X2R should be calibrated every 6 months, if ongoing accurate levelling is required or an impact has occurred.
- ▶ The operator should check the X2R for accuracy before precision levelling is attempted.
- ▶ Clean the instrument with a dry, soft cloth after use in dusty, damp or wet conditions before storing.
- ▶ Smudges and fingerprints may be removed with a damp tissue or a soft, lint-free cloth.

WARRANTY

The Powerline X2R comes with a 3 year manufacturers warranty.

Our goods come with guarantees that cannot be excluded under the Australian Consumer Law. You are entitled to a replacement or refund for a major failure and for compensation for any other reasonably foreseeable loss or damage. You are also entitled to have the goods repaired or replaced if the goods fail to be of acceptable quality and the failure does not amount to a major failure.

Separate to the above Australia Consumer Law, *Spot-on* offers a global warranty.

30 Day Free Service

If your laser is out of calibration within the first 30 days of purchase you are entitled to a free calibration adjustment. For more information please contact your retailer or *Spot-on*.

Customer Support

To assist you with any queries or technical questions please contact the customer support line: 1300 658 338

SPECIFICATIONS

Specifications	Powerline X2R
Product code	50060
Warranty	3 Years
Accuracy	±2mm at 10m
Range	50m (detector)
Levelling range	±4°
Laser class	2 Red
Battery life	10 hours
Battery type	3x AA
Vertical lines	1
Horizontal lines	1
IP rating	54
Weight (kg)	0.45
Dimensions (mm)	95x60x115

www.spoton.com.au

