



CP-ISP10
INSPECTION CAMERA



INSTRUCTION MANUAL

Safety

Read the following safety instructions before attempting to operate this product.

Keep these instructions in a safe place for future reference.

SAVE ALL WARNINGS AND INSTRUCTIONS FOR FUTURE REFERENCE.



WARNING!

Read and understand all instructions.

- Use only accessories that are recommended for your model.
- Tool service must be performed only by qualified repair personnel. Repairs, service or maintenance performed by unqualified personnel will void the warranty. Only approved and authorised service technicians can carry out warranty repairs.
- Position the tool securely on a level surface. Damage to the tool or serious injury could result if the tool falls.



WARNING!

Do not disassemble the tool

There are no user serviceable parts inside. Disassembling the tool will void all warranties on the product. Do not modify the product in any way.

Item Checklist

Please ensure the following items are included with your inspection camera. If anything is missing please contact your retailer.

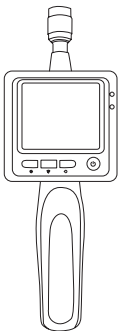

Centre Point CP-ISP10



Rubber cap

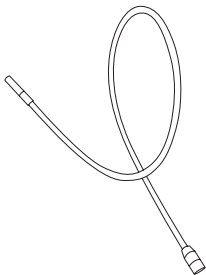

Camera cable



Hook



Magnet



Mirror

Inspection Camera Overview

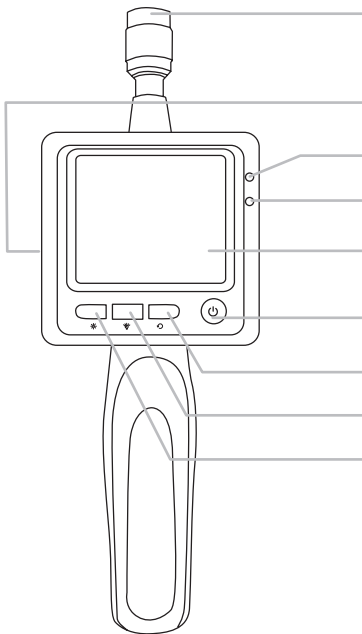

Camera connection point

Battery compartment

Power indicator

Low battery indicator

LCD screen

Power

Screen rotation

Brightness control

Contrast control

Using Your Inspection Camera

POWER SUPPLY

- The CP-ISP10 is powered by four AA batteries

Battery replacement

- Remove the battery door cover.
- Remove the batteries from the battery case.
- Insert the new batteries according to polarity and insert the battery case.
- Replace the battery door cover.

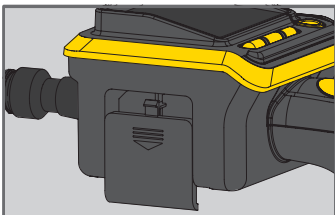

Open the battery door

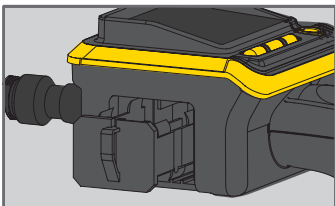

Remove the battery compartment

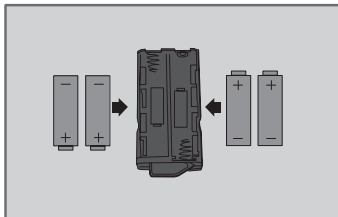

Insert the batteries according to polarity

Using Your Inspection Camera

SETTING UP

Attaching the camera cable

- To attach the camera cable to the monitor, make sure the keyed end of the tube is aligned with the slot in the handle.
- Push together with slight force and twist clockwise to connect securely in place.

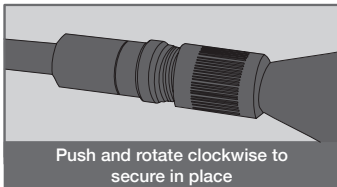
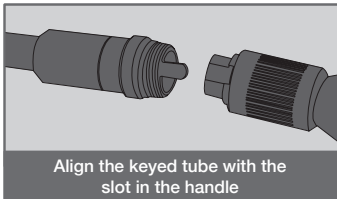

(continued)

Attaching the accessories

- To install the mirror, hook or magnet place the hooked end into the hole at the camera head.
- Place the rubber cap around the camera head and hook to secure into place.

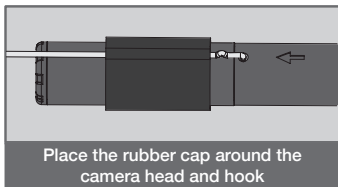
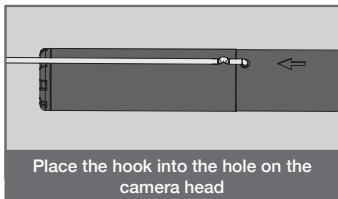

Using Your Inspection Camera

OPERATION

- Press the power switch to turn the camera on. The power indicator will light and the LCD screen will become active.
- If the image on screen is unclear, adjust the brightness or contrast by pressing the *brightness control* or *contrast control* buttons on the unit.
- To rotate the orientation of the image displayed, press the *screen rotation* button to cycle through each angle.
- Maneuver and adjust the camera cable into position.



The camera cable can be bent into numerous shapes that can help you inspect areas that are normally out of view.



To avoid damage to the camera cable it is recommended not to bend the cable at an angle greater than 90°.

(continued)



WARNING! Do not immerse the monitor into water. Only the lens and tube are water resistant once the unit is fully assembled.

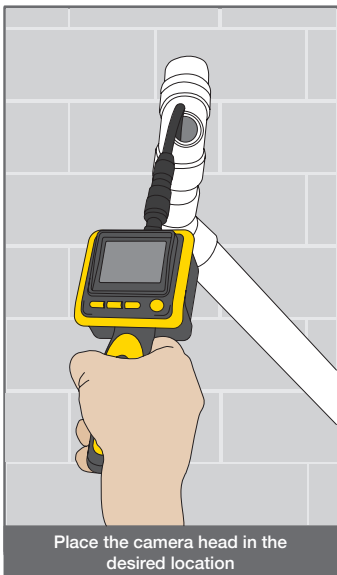

Care & Maintenance

- Whenever possible, store the instrument in a dry, shady location.
 - Clean the instrument with a dry, soft cloth after use in dusty, damp or wet conditions before storing.
 - Smudges and fingerprints may be removed with a damp tissue or a soft, lint-free cloth.
 - Remove the alkaline batteries from the tool before storing for extended periods.
-  Only the lens and camera cable are water resistant. Do not expose the monitor to wet conditions.

Warranty

The Centre Point CP-ISP10 comes with a 3 (three) year warranty.

1. The warranty period for your tool is 3 years from the date of purchase.
2. To claim under the warranty, the date of purchase of the tool must be documented by an invoice/receipt.
3. Damage and general wear and tear is not covered by warranty.

AUSTRALIA

“Our goods come with guarantees that cannot be excluded under the Australian Consumer Law. You are entitled to a replacement or refund for a major failure and for compensation for any other reasonably foreseeable loss or damage. You are also entitled to have the goods repaired or replaced if the goods fail to be of acceptable quality and the failure does not amount to a major failure.”

For more information please visit consumerlaw.gov.au

NEW ZEALAND

For more information please visit consumerprotection.govt.nz

Customer Support

To assist you with any queries or technical questions please contact customer support

Australia: 1300 658 338

New Zealand: 0800 367 527

United Kingdom: 0808 189 1152

Specifications

Specifications	Centre Point CP-ISP10
Product code	400060
Warranty	3 Years
Resolution	640 x 480px
Display	2.4" TFT LCD colour
Camera lens width	9mm (diameter)
Night vision range	0.5m
Battery type	4x AA alkaline batteries
IP rating	67
Weight (kg)	0.4
Dimensions (mm)	201 x 83 x 59



www.spoton.com.au