

CP-R20R
ROTARY LASER



I N S T R U C T I O N M A N U A L

Safety

Read the following safety instructions before attempting to operate this product.

Keep these instructions in a safe place or store in the carry case for future reference.

SAVE ALL WARNINGS AND INSTRUCTIONS FOR FUTURE REFERENCE.



WARNING!

Read and understand all instructions.

- Use the laser only with the specifically designated batteries.
- Store the laser out of reach of children and other untrained persons. Lasers are dangerous in the hands of untrained users.
- Use only accessories that are recommended for your model.
- Tool service must be performed only by qualified repair personnel. Repairs, service or maintenance performed by unqualified personnel will void the warranty. Only approved and authorised service technicians can carry out warranty repairs.
- Do not use optical tools such as a telescope or transit to view the laser beam. Serious eye injury could result.
- Do not place the laser in a position which may cause anyone to intentionally or unintentionally stare into the laser beam. Serious eye injury could result.
- Do not position the laser near a reflective surface which may reflect the laser beam toward anyone's eyes. Serious eye injury could result.
- Do not use optical tools to view the laser beam.
- Do not set up the tool at a position where the laser beam can cross any person at head height.
- Do not let children come in contact with the laser.

Safety *(continued)*

- Turn the laser off when it is not in use. Leaving the laser on increases the risk of staring into the laser beam.
- Do not operate the laser around children or allow children to operate the laser. Serious eye injury may result.
- Do not remove or deface warning labels.
- Position the laser securely on a level surface. Damage to the laser or serious injury could result if the laser falls.



WARNING!
DO NOT DISASSEMBLE THE LASER.

There are no user serviceable parts inside. Disassembling the laser will void all warranties on the product. Do not modify the product in any way. Modifying the tool may result in hazardous laser radiation exposure.



CAUTION!
Class 2 Laser Product.

- Never look into the laser beam directly and intentionally.
- Do not use optical tools to view the laser beam.
- Do not set up the tool at a position where the laser beam can cross any person at head height.
- Do not let children come in contact with the laser.

Item Checklist

Please ensure the following items are included with your optical level.
If anything is missing please contact your retailer.

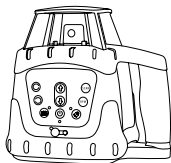

Centre Point
CP-R20R



Remote control

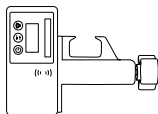

Detector & clamp



Laser target



Laser glasses



Charger



Rechargeable
battery pack (laser
level)



1x 9v alkaline
battery (detector)



2x AAA alkaline
batteries (remote)

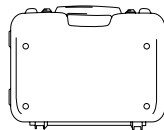

Carry case

Laser Overview: Front

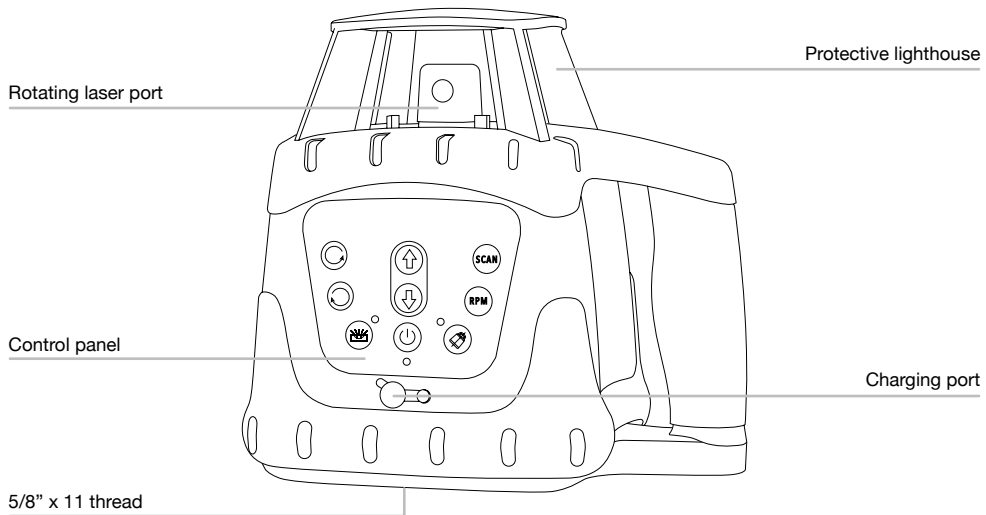

Laser Overview: Base

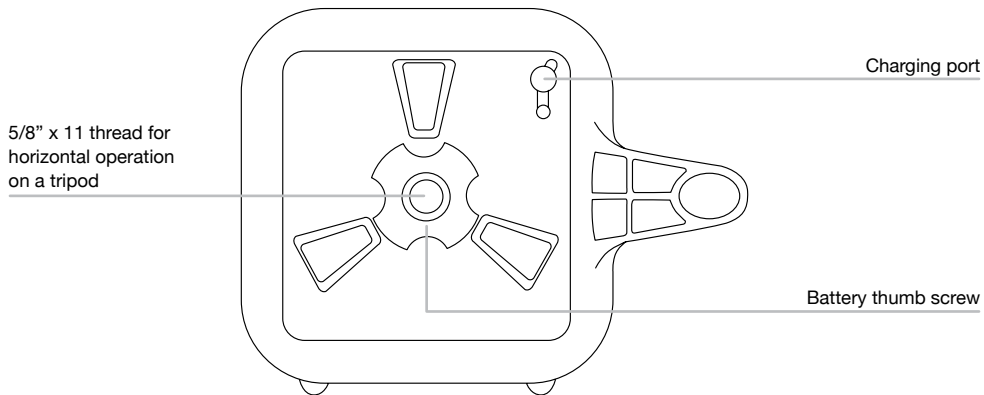

Laser Overview: Control Panel

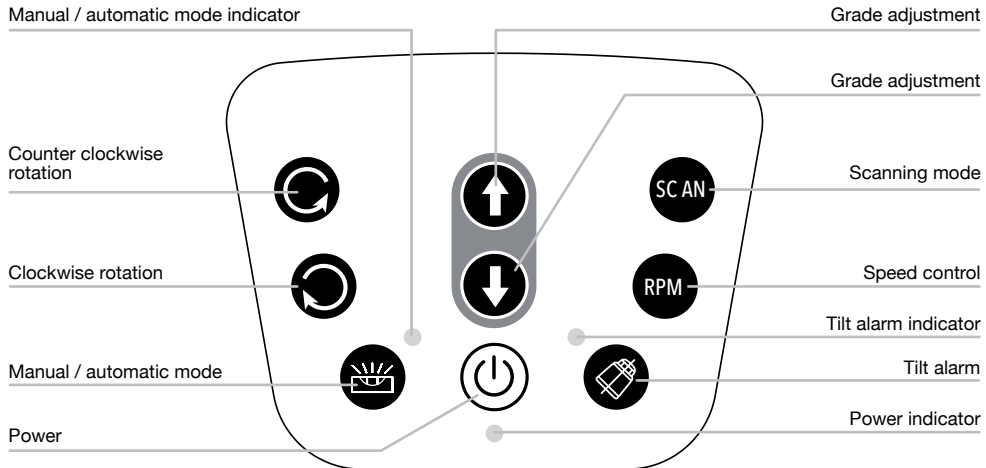

Remote Control Overview: Front

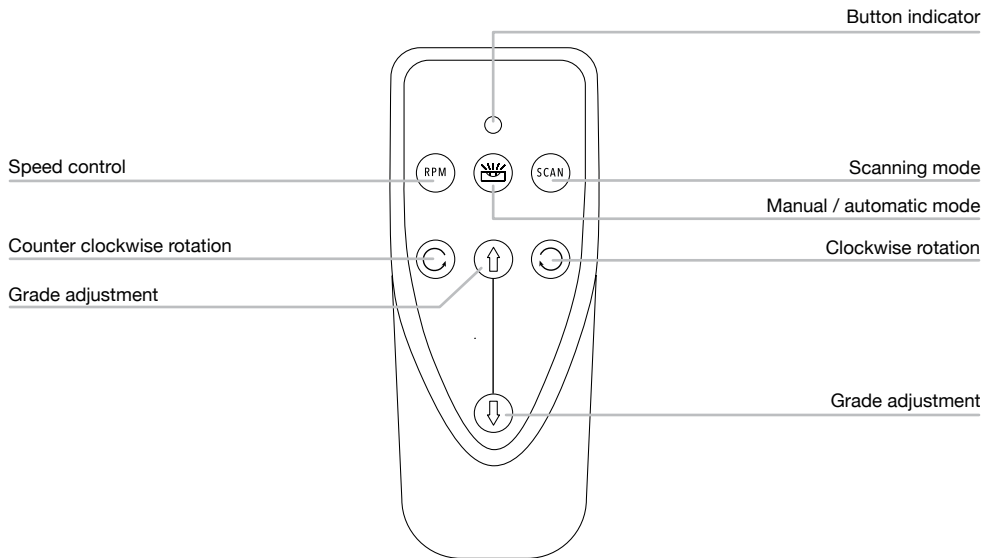

Remote Control Overview: Back

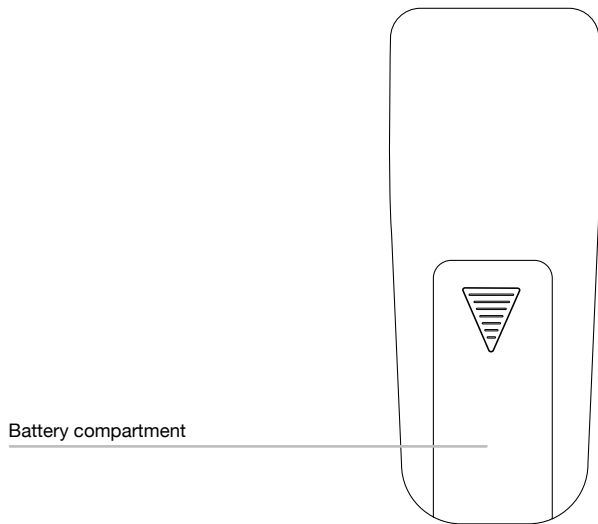

Detector Overview: Front

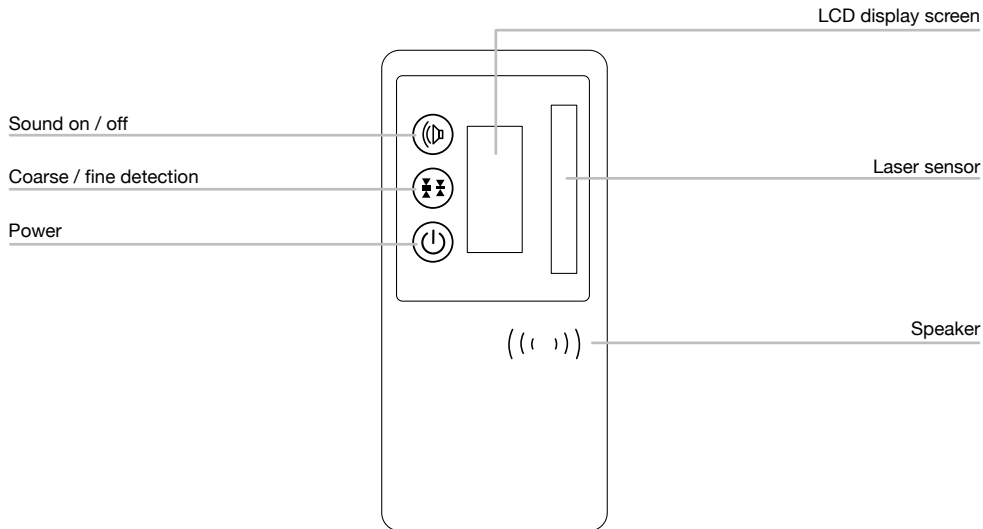

Detector Overview: LCD Screen

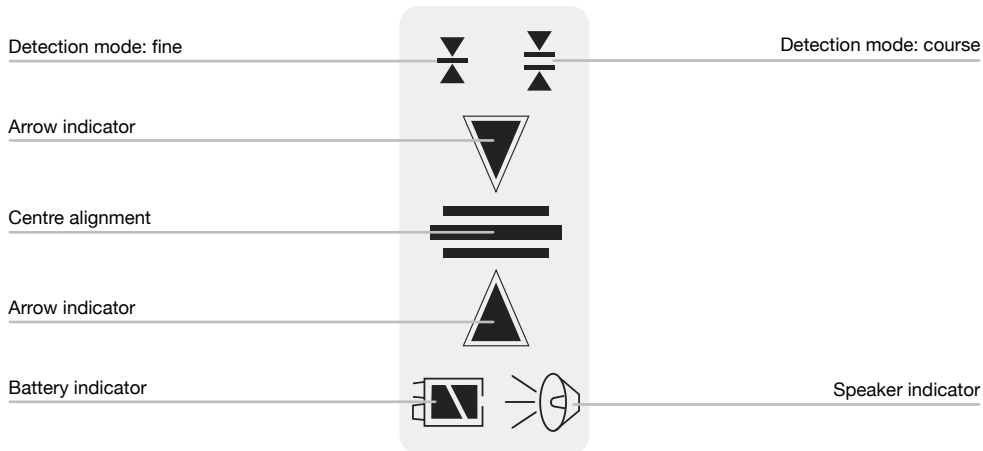

Detector Overview: Back

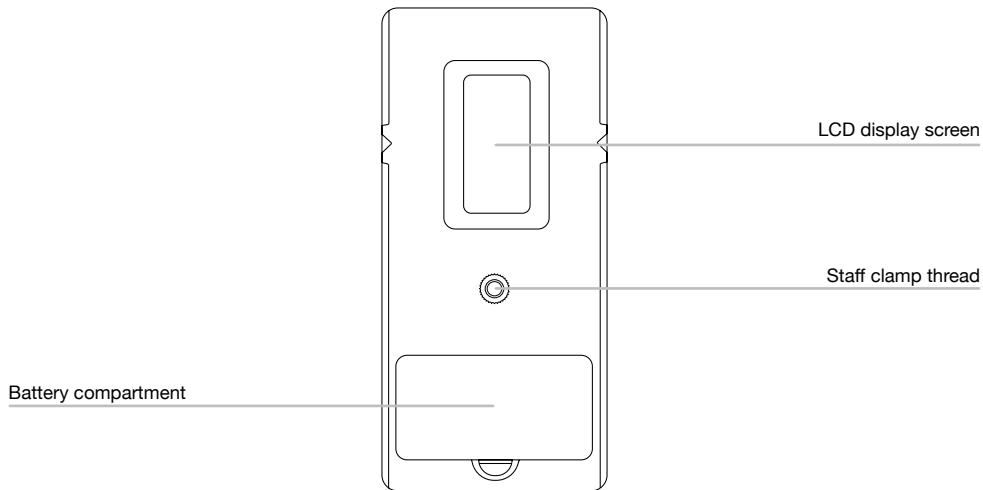

Using Your Laser

POWER SUPPLY

Rechargeable battery pack

- The instrument is supplied with a rechargeable Ni-MH battery pack that is located in the base of the instrument.
- The rechargeable battery pack is supplied only partially charged. Charge the rechargeable battery pack before use. Keep the rechargeable battery pack in the carry case when not in the laser level.
- The power indicator light will flash when the battery is low. The instrument should be recharged as soon as possible.
- Battery pack capacity decreases at low temperatures; a depleted pack may not function when cold.

Indoor charger

- The indoor charger is for indoor use only.
- Do not store in locations where moisture can be present or where the chargers could be exposed to extreme temperatures.
- If a charger becomes damaged, stop using immediately and seek a replacement.





WARNING: Only use the supplied charger. Using an incorrect charger will void the warranty. Do not charge alkaline batteries.

Using Your Laser (continued)

Charging the rechargeable battery pack

- Insert the charger into one of the two charging ports. The charging ports are located on the battery pack and underneath the control panel. Progress will be shown by the power indicator display on the charger as below:

 Red (flashing) = Charger and battery are not connected.

 Red (constant) = Battery is charging

 Green (constant) = Battery is charged

- Charging time is approximately 5 hours for a depleted battery.

 The battery pack does not need to be inserted in the laser whilst charging via the port on the battery pack.

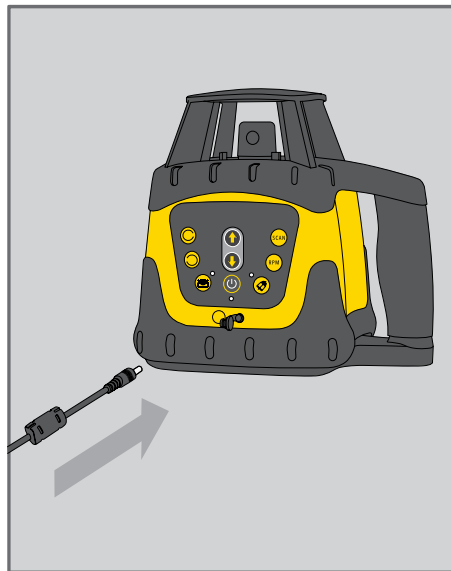

Using Your Laser *(continued)*

Removing and inserting the rechargeable battery pack

- Loosen the battery thumb screw on the base of the instrument and remove the battery pack.
- Insert the battery pack, ensuring the metal pins are aligned. Tighten the battery thumb screw.



WARNING: Do not attempt to disassemble the battery pack.

SET UP

- Select a place as close as practical to the work site. Ensure the location is clear of traffic.
- Place the laser on a level surface such as a bench or mount.

Using Your Laser *(continued)*

HORIZONTAL MEASUREMENT SET UP

Level surface set up

- Select a place as close and practical to the work site as possible, and ensure that the location is clear of traffic.
- Place the laser level onto a reasonably level surface with the lighthouse facing upwards.

Mounting to a construction tripod



The construction tripod is an optional accessory which can be purchased from your retailer.

- Extend the tripod legs to the required height and then spread the legs wide enough so that the tripod platform is stable.
- Place the laser level onto the tripod with the lighthouse facing upwards and thread the yoke into the base until firm. Do not over tighten as this may cause damage to the laser level or tripod.



WARNING! Attaching the instrument to a tripod without the correct thread size as your instrument may cause damage.



Instructions are for a domed or flat construction tripod only.

Using Your Laser (continued)

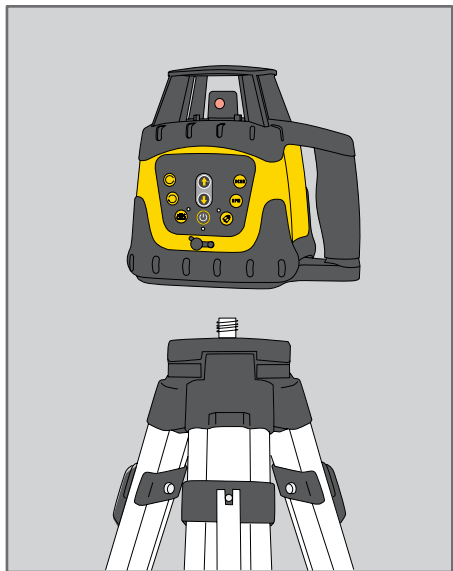

Using Your Laser *(continued)*

OPERATION

Powering on

- Press the power button once and the instrument will power on and begin automatically self-levelling. When this levelling process is complete, the penta prism inside the lighthouse will start rotating.
- If the instrument is outside the self levelling range the instrument will not level causing the laser beam to flash continuously. If this occurs, reposition the instrument onto a level surface until the instrument can level off.

Powering off

- Press the power button once and the instrument will power off.

Speed control

- Press the speed control button to cycle through various rotational speeds.
- The speed control indicator will flash slowly when speed is slow and fast when speed is increased.

Scanning mode

- To focus the laser beam between two points press the scanning mode button.
Pressing the button multiple times will adjust the angle of the beam.
- To cancel scan mode press the scanning mode button several times to cycle through to full rotation.

Using Your Laser *(continued)*

Rotation direction

- Whilst the instrument is in scanning mode press the clockwise or counter clockwise button to change the rotation of the laser head. button to change the rotation of the laser head.

Tilt alarm

- Once the instrument has been levelled off the tilt alarm can be enabled by pressing the tilt alarm button. The tilt alarm indicator light will flash continuously whilst active.
- If the instrument is disturbed while the alarm is active the instrument will stop rotating and will need to be powered off and on again to reset its level position.

Setting up a grade / slope

- To create a slope / grade, enter into manual mode by pressing the manual / automatic mode button on either the instrument or remote control.
- The manual / automatic mode indicator on the instrument will light up when manual mode is active.
- To adjust the grade, press the grade adjustment arrows on either the instrument or remote control.
- To cancel out of manual mode press the manual / automatic mode button.



When in manual mode the instrument will not self level and correct for vibrations and/or disturbances.

Using Your Remote

POWER SUPPLY

- The remote is powered by two AAA alkaline batteries.

Battery replacement

- Remove the battery door cover.
- Insert the battery according to polarity and replace the battery door.

OPERATION

- Ensure the instrument is turned on and the laser head is rotating.
- Press the speed control button to increase or decrease the speed of the laser head rotation.
- To focus the laser beam between two points press the scanning mode button. Pressing the button multiple times will adjust the angle of the beam.
- Press the clockwise or counter clockwise button to change the rotation of the laser head while the instrument is in scan mode.
- To create a grade / slope press the grade adjustment arrows.

Using Your Detector

POWER SUPPLY

- The detector is powered by a 9V alkaline battery.

Battery replacement

- Remove the battery door cover.
- Insert the battery according to polarity and replace the battery door.

MOUNTING THE STAFF CLAMP

- Insert the staff clamp screw into the staff clamp thread.
- Rotate the nut until the clamp is secured in place.

Using Your Detector *(continued)*

OPERATION

- Switch the detector on by pressing the power button. The speaker will beep once indicating the instrument is operating.
- The LCD screen will display the battery level, detection mode and speaker function.
- To change between coarse and fine mode press the coarse / fine mode button
- Hold the detector upright and move into the path of the laser beam.
- The direction arrows or level line on the LCD screen will indicate the position of the laser beam. The detector will emit a constant beep once the level position has been located.

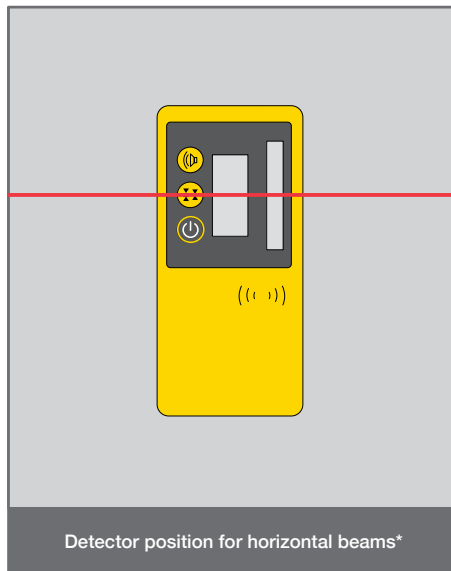

Checking Calibration

Before doing any precision levelling it is advised to check the calibration of the instrument.

- Set up the laser on a tripod at about 30m facing a wall or staff with a detector.
- Allow the instrument to level.
- Detect and note laser position on the wall or staff.
- Without moving the tripod rotate the instrument 180°.
- Detect and note laser position on the wall or staff.
- Calculate the distance between the two readings.
- The difference should be within 6mm at 30m.
- If the instrument is out of calibration it is advised to send it in to Spot-on.
(see www.spoton.com.au for details)

Trouble Shooting

Error	Cause & Solution
Laser does not turn on	<ul style="list-style-type: none">• Check the batteries. They may be in the wrong way or need replacing.• Check the battery compartment for signs of damage. Ensure they are clean and not bent.• Connect the mains power adaptor.
Laser turns on but does not rotate	<ul style="list-style-type: none">• Check the batteries.• Check the battery compartment for signs of damage. Ensure they are clean and not bent.• Connect the main power adaptor
Laser does not remain on for long periods of time	<ul style="list-style-type: none">• Check the batteries.• Check the battery compartment for signs of damage. Ensure they are clean and not bent.• Connect the main power adaptor.
Laser does not level off	<ul style="list-style-type: none">• Instrument may be outside its self levelling range. Adjust the instrument or tripod so it is level.• Instrument may have low power.• Instrument may have impact damage.
Detector does not detect the laser beam	<ul style="list-style-type: none">• Check the batteries.• Check that the laser is operating correctly.
Detector speaker is not functioning	<ul style="list-style-type: none">• Check sound is on.• Check the laser is operating correctly and producing a beam.

Care & Maintenance

- This is a precision measuring instrument and should always be handled with care and transported within the carry case provided.
- Whenever possible, store the instrument in a dry, shady location.
- Calibration of the instrument is recommended: every six months, if ongoing accurate levelling is required, or an impact has occurred.
- The operator should check the accuracy of the instrument before precision levelling is attempted. Failure to do so may result in inaccurate measurements.
- Clean the instrument with a dry, soft cloth after use in dusty, damp or wet conditions before storing.
- Smudges and fingerprints may be removed with a damp tissue or a soft, lint-free cloth.

Warranty

3 YEAR STANDARD WARRANTY PERIOD

1. The warranty period for your Centre Point tool is 3 years from the date of purchase.
2. The warranty period for batteries, battery packs and chargers is 1 year from the date of purchase.
3. All products have a standard warranty period, you do not have to register your products to obtain the standard warranty period.
4. To claim under this warranty, the date of purchase of the Lasertec tool must be documented by an invoice/receipt.

7 YEAR EXTENDED WARRANTY PERIOD

1. The extended warranty is available on selected tools only.
2. You may extend the warranty period for your Lasertec tool to 7 years from the date of purchase. This excludes batteries, battery packs and chargers.
3. To obtain the extended warranty, the registration process must be completed within 30 days from the date of purchase.
4. Failure to register your product online and/or submission of a valid invoice/receipt will void the warranty extension.
5. Please ensure ALL information submitted/uploaded is correct.
6. Extended warranty is ONLY available via online registration, offline (mailing in of warranty registration) will not be accepted.

Warranty *(continued)*

AUSTRALIA

“Our goods come with guarantees that cannot be excluded under the Australian Consumer Law. You are entitled to a replacement or refund for a major failure and for compensation for any other reasonably foreseeable loss or damage. You are also entitled to have the goods repaired or replaced if the goods fail to be of acceptable quality and the failure does not amount to a major failure.”

For more information please visit
consumerlaw.gov.au

NEW ZEALAND

For more information please visit
consumerprotection.govt.nz

Customer Support

To assist you with any queries or technical questions please contact customer support

Australia: 1300 658 338

New Zealand: 0800 367 527

Specifications

Specifications	Centre Point CP-R20R
Product code	400009
Warranty	7 Years*
Accuracy	±1.5mm at 30m
Operating range	500m (diameter)
Levelling range	±9% / ±5°
Laser class	2 Red
Battery life	20 hours
IP rating	65
Weight (kg)	2.00
Dimensions (mm)	200 x 200 x 150

*With online registration. Please refer to page 26 for details.



www.spoton.com.au