

GENERAL

A1

ROTARY LASER



INSTRUCTION MANUAL

SAFETY

Read the following safety instructions before attempting to operate this product.

Keep these instructions in a safe place or store in the carry case for future reference.

SAVE ALL WARNINGS AND INSTRUCTIONS FOR FUTURE REFERENCE.

 **WARNING:** Read and understand all instructions.

- Use the laser only with the specifically designated batteries.
- Store the laser out of reach of children and other untrained persons. Lasers are dangerous in the hands of untrained users.
- Use only accessories that are recommended for your model.
- Tool service must be performed only by qualified repair personnel. Repairs, service or maintenance performed by unqualified personnel will void the warranty. Only approved and authorised service technicians can carry out warranty repairs.
- Do not use optical tools such as a telescope or transit to view the laser beam. Serious eye injury could result.
- Do not place the laser in a position which may cause anyone to intentionally or unintentionally stare into the laser beam. Serious eye injury could result.
- Do not position the laser near a reflective surface which may reflect the laser beam toward anyone's eyes. Serious eye injury could result.
- Do not use optical tools to view the laser beam.

- Do not set up the tool at a position where the laser beam can cross any person at head height.
- Do not let children come in contact with the laser.
- Turn the laser off when it is not in use. Leaving the laser on increases the risk of staring into the laser beam.
- Do not operate the laser around children or allow children to operate the laser. Serious eye injury may result.
- Do not remove or deface warning labels.
- Position the laser securely on a level surface. Damage to the laser or serious injury could result if the laser falls.

 **WARNING: DO NOT DISASSEMBLE THE LASER.** There are no user serviceable parts inside. Disassembling the laser will void all warranties on the product. Do not modify the product in any way. Modifying the tool may result in hazardous laser radiation exposure.

 **CAUTION: Class 2 Laser Product**

- Never look into the laser beam directly and intentionally.
- Do not use optical tools to view the laser beam.
- Do not set up the tool at a position where the laser beam can cross any person at head height.
- Do not let children come in contact with the laser.

ITEM CHECKLIST

Please ensure the following items are included with your laser level.
If anything is missing please contact your retailer.

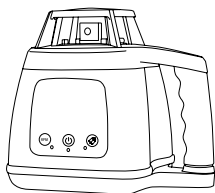

General A1

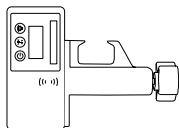

Detector & clamp

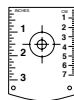

Laser target



Laser glasses

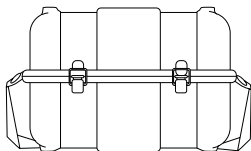

Carry case

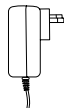

Charger



Rechargeable
battery pack

LASER OVERVIEW: FRONT

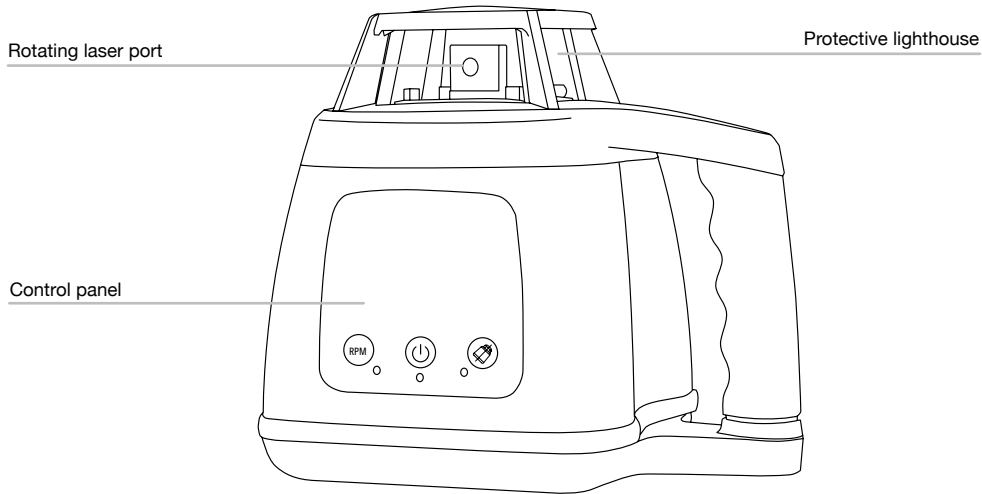

LASER OVERVIEW: BASE

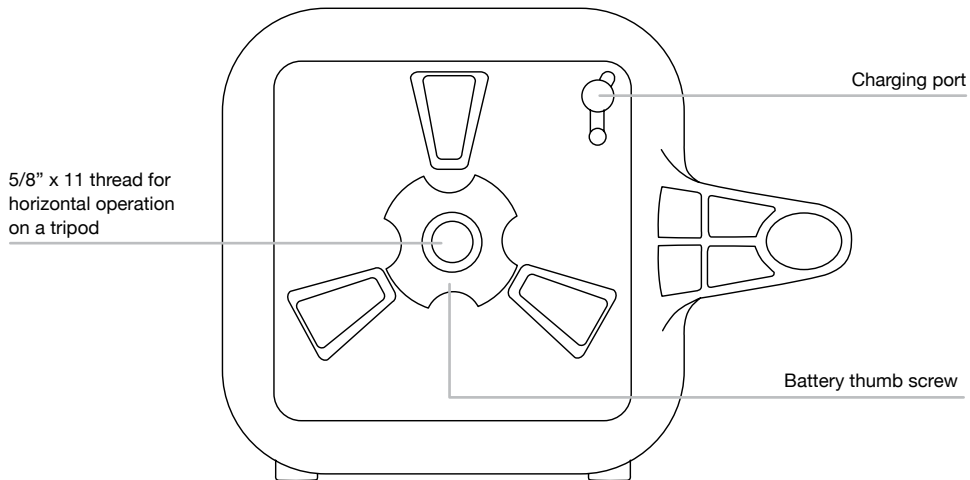

LASER OVERVIEW: CONTROL PANEL

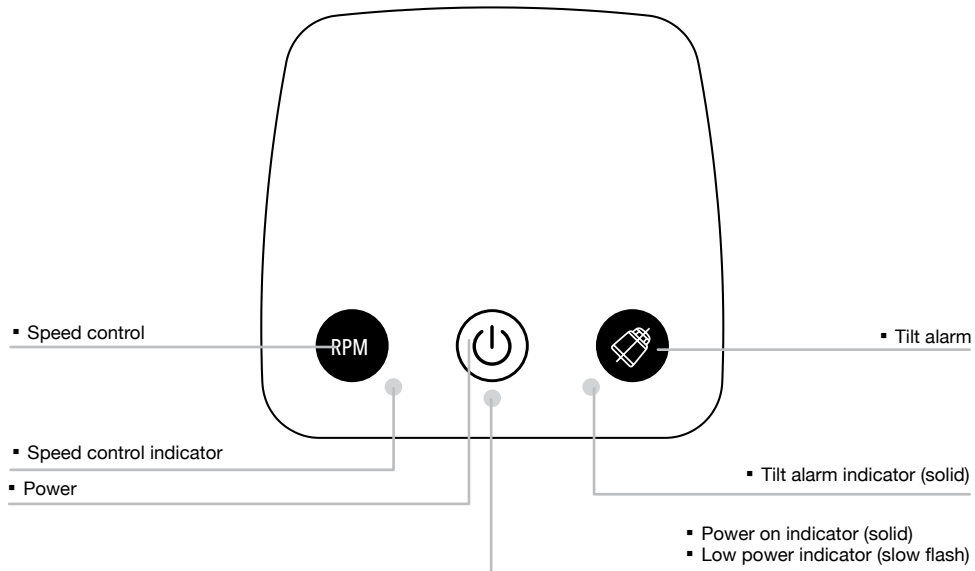

DETECTOR OVERVIEW: FRONT

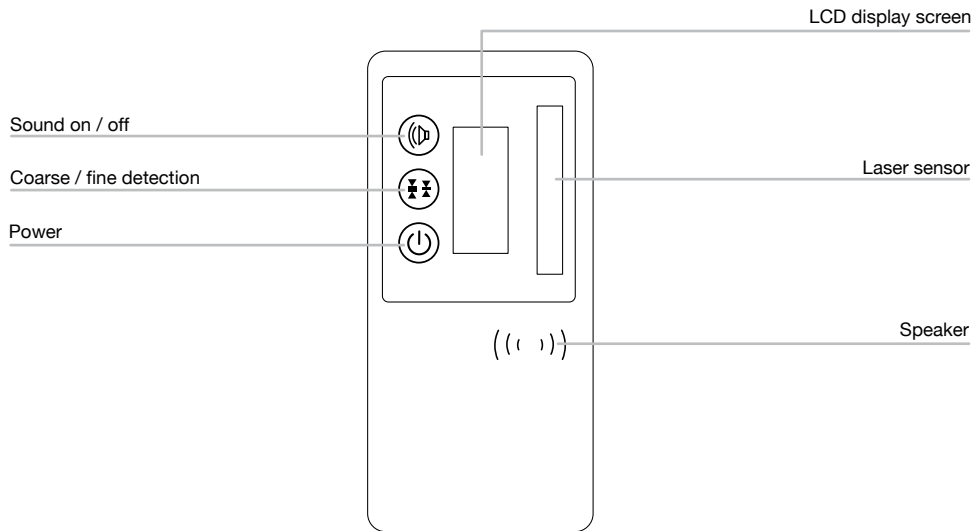

DETECTOR OVERVIEW: BACK

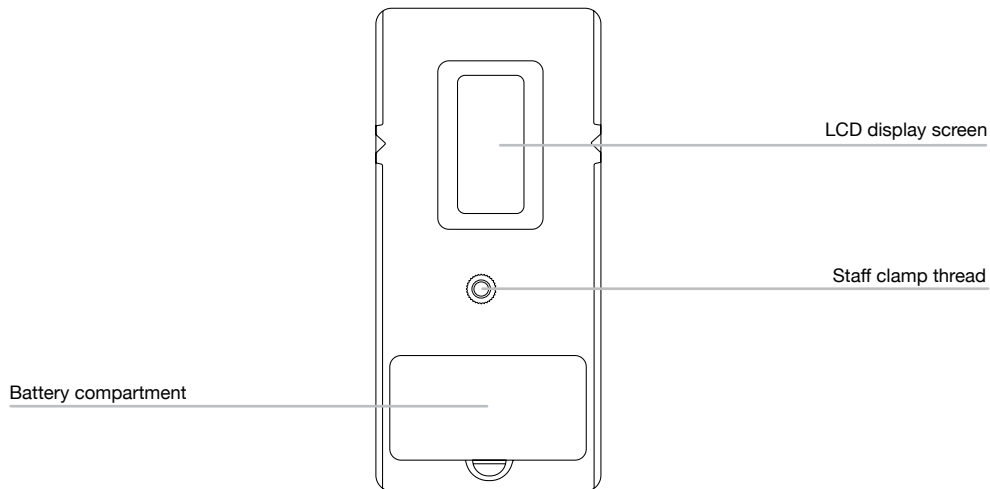

USING YOUR LASER

POWER SUPPLY

Rechargeable battery pack

- The instrument is supplied with a rechargeable Ni-MH battery pack that is located in the base of the instrument.
- The rechargeable battery pack is supplied only partially charged. Charge the rechargeable battery pack before use. Keep the rechargeable battery pack in the carry case when not in the laser level.
- The power indicator light will flash when the battery is low. The instrument should be re-charged as soon as possible.
- Battery pack capacity decreases at low temperatures; a depleted pack may not function when cold.

Indoor charger

- The indoor charger is for indoor use only.
- Do not store in locations where moisture can be present or where the chargers could be exposed to extreme temperatures.
- If a charger becomes damaged, stop using immediately and seek a replacement.





WARNING: Only use the supplied charger. Using an incorrect charger will void the warranty. Do not charge alkaline batteries.

POWER SUPPLY *(continued)*

Charging the rechargeable battery pack

▪ Insert the charger into the charging port on the battery pack. Progress will be shown by the power indicator display on the charger as below

 *Red (flashing)* = Charger and battery are not connected.

 *Red (constant)* = Battery is charging

 *Green (constant)* = Battery is charged

▪ Charging time is approximately 5 hours for a depleted battery.

 The battery pack does not need to be inserted in the laser whilst charging via the port on the battery pack.

Removing & inserting the rechargeable battery pack

▪ Loosen the battery thumb screw on the base of the instrument and remove the battery pack.

▪ Insert the battery pack ensuring the metal pins are aligned and tighten the battery thumb screw.

 The battery pack does not need to be inserted in the laser whilst charging.

 **WARNING: Do not attempt to disassemble the battery pack.**

HORIZONTAL MEASUREMENT SET UP

Level surface set up

- Select a place as close and practical to the work site as possible, and ensure that the location is clear of traffic.
- Place the laser level onto a reasonably level surface with the lighthouse facing upwards.

Tripod set up

- Select a place as close and practical to the work site as possible, and ensure that the location is clear of traffic.
- Extend the tripod legs to the required height and then spread the legs wide enough so that the tripod platform is stable.
- Place the laser level onto the tripod with the lighthouse facing upwards and thread the yoke into the base until firm. Do not over tighten as this may cause damage to the laser level or tripod.

OPERATION

Powering on

- Press the power button once and the instrument will power on and begin automatically self-levelling. When this levelling process is complete, the penta prism inside the lighthouse will start rotating.
- If the instrument is outside the self levelling range the instrument will not level causing the laser beam to flash continuously. If this occurs, reposition the instrument onto a level surface until the instrument can level off.

Powering off

- Press the power button once and the instrument will power off.

Speed control

- Press the speed control button to cycle through various rotational speeds.
- The speed control indicator will flash slowly when speed is slow and fast when speed is increased.

Tilt alarm

- Once the instrument has been levelled off the tilt alarm can be enabled by pressing the tilt alarm button. The tilt alarm indicator light will flash continuously whilst active.
- If the instrument is disturbed while the alarm is active the instrument will stop rotating and will need to be powered off and on again to reset its level position.

USING YOUR DETECTOR

Power supply

- The detector is powered by a 9V alkaline battery.

Mounting the staff clamp

- Insert the staff clamp screw into the staff clamp thread.
- Rotate the nut until the clamp is secured in place.

Battery replacement

- Remove the battery door cover.
- Insert the battery according to polarity and replace the battery door.

Detector operation

- Switch the detector on by pressing the *power* button. The speaker will beep once indicating the instrument is operating.
- The LCD screen will display the battery level, detection mode and speaker function.
- To change between coarse and fine mode press the *coarse / fine mode* button
- Move the detector into the path of the laser beam.
- Hold the detector upright for horizontal beams.
- The direction arrows or level line on the LCD screen will indicate the position of the laser beam. The detector will emit a constant beep once the level position has been located.

USING YOUR DETECTOR *(continued)*

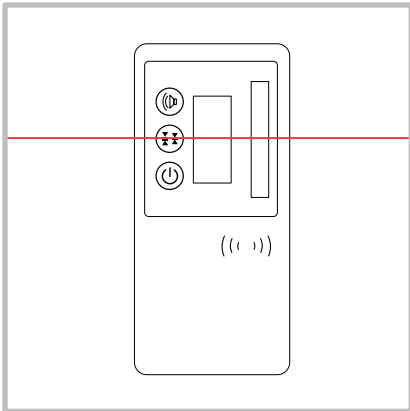

Detector position for horizontal beams

CHECKING CALIBRATION

Before doing any precision levelling it is advised to check the calibration of the instrument.

- Set up the laser on a tripod at about 30m facing a wall or staff with a detector.
- Allow the instrument to level.
- Detect and note laser position on the wall or staff.
- Without moving the tripod rotate the instrument 180°.
- Detect and note laser position on the wall or staff.
- Calculate the distance between the two readings.

- The difference should be within 6mm at 30m.
- If the instrument is out of calibration it is advised to send it in to Spot-on.

(see www.spoton.com.au for details)

TROUBLE SHOOTING

Error	Cause & Solution
Laser does not turn on	<ul style="list-style-type: none">• Check the batteries. They may be in the wrong way or need replacing.• Check the battery compartment for signs of damage. Ensure they are clean and not bent.• Connect the mains power adaptor.
Laser turns on but does not rotate	<ul style="list-style-type: none">• Check the batteries.• Check the battery compartment for signs of damage. Ensure they are clean and not bent.• Instrument may be outside its self levelling range. Adjust the instrument or tripod so it is level.
Laser does not remain on for long periods of use.	<ul style="list-style-type: none">• Check the batteries.• Check the battery compartment for signs of damage. Ensure they are clean and not bent.• Connect the main power adaptor.
Laser does not level off	<ul style="list-style-type: none">• Instrument may be outside its self levelling range. Adjust the instrument or tripod so it is level.• Instrument may have low power.• Instrument may have impact damage.
Detector does not detect the laser beam	<ul style="list-style-type: none">• Check the batteries.• Check that the laser is operating correctly.
Detector speaker is not functioning	<ul style="list-style-type: none">• Check sound is on.• Check the laser is operating correctly and producing a beam.

CARE AND MAINTENANCE

- Reflective surfaces such as glass may reflect the beam, causing two beams to strike the detector at the same time. This may create inaccurate reference points.
- This is a precision measuring instrument and should always be handled with care and transported within the carry case provided.
- Whenever possible, store the instrument in a dry, shady location.
- Calibration of the instrument is recommended: every six months, if ongoing accurate levelling is required, or an impact has occurred.
- The operator should check the accuracy of the instrument before precision levelling is attempted. Failure to do so may result in inaccurate measurements.
- The supplied charger is specific to this product. Do not purchase or use any other type of charger or power adaptor.
- Clean the instrument with a dry, soft cloth after use in dusty, damp or wet conditions before storing.
- Smudges and fingerprints may be removed with a damp tissue or a soft, lint-free cloth.

WARRANTY

The General A1 comes with a 3 (three) year manufacturers warranty.

AUSTRALIA

“Our goods come with guarantees that cannot be excluded under the Australian Consumer Law. You are entitled to a replacement or refund for a major failure and for compensation for any other reasonably foreseeable loss or damage. You are also entitled to have the goods repaired or replaced if the goods fail to be of acceptable quality and the failure does not amount to a major failure.”

For more information please visit consumerlaw.gov.au

NEW ZEALAND

For more information please visit consumerprotection.govt.nz

CUSTOMER SUPPORT

To assist you with any queries or technical questions please contact customer support

Australia: 1300 658 338

New Zealand: 0800 367 527

SPECIFICATIONS

Specifications	General A1
Product code	70005
Warranty	3 Years
Accuracy	±2mm at 30m
Operating range	300m (diameter)
Levelling range	±9% / ±5°
Laser class	2 Red
Battery life	20 hours
Battery type	4x C (sealed pack)
IP rating	65
Weight (kg)	1.85
Dimensions (mm)	185 x 195 x 150

NOTES

NOTES



www.spoton.com.au