

GENERAL

ML-3DR MULTI-LINE LASER LEVEL

PREMIUM LASER KIT

Product Code: GML3DRPMKT

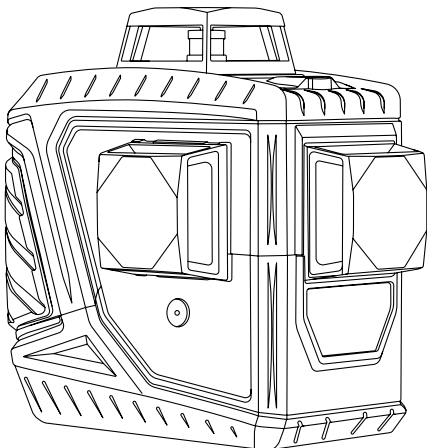

INSTRUCTION MANUAL

Laser Safety

Read the following safety instructions before attempting to operate this tool.
Keep these instructions in a safe place or store in the carry pouch for future reference.



WARNING! SAVE ALL WARNINGS & INSTRUCTIONS FOR FUTURE REFERENCE.

Read and understand all instructions.

- Use the tool only with the specifically designated batteries.
- Store the tool out of reach of children and other untrained persons. Laser tools are dangerous in the hands of untrained users.
- Use only accessories that are recommended for your model.
- Tool service must be performed only by qualified repair personnel. Repairs, service or maintenance performed by unqualified personnel will void the warranty. Only approved and authorised service technicians can carry out warranty repairs.
- Do not use optical tools such as a telescope or transit to view the laser beam. Serious eye injury could result.
- Do not place the tool in a position which may cause anyone to intentionally or unintentionally stare into the laser beam. Serious eye injury could result.
- Do not position the tool near a reflective surface which may reflect the laser beam toward anyone's eyes. Serious eye injury could result.
- Do not set up the tool at a position where the laser beam can cross any person at head height.
- Do not let children come in contact with the tool.
- Turn the tool off when it is not in use. Leaving the tool on increases the risk of staring into the laser beam.
- Do not operate the tool around children or allow children to operate the tool. Serious eye injury may result.
- Position the tool securely on a level surface. Damage to the laser or serious injury could result if the laser falls.
- Do not remove or deface warning labels.



WARNING! **DO NOT DISASSEMBLE THE LASER.**

There are no user serviceable parts inside. Disassembling the tool will void all warranties on the product. Do not modify the tool in any way. Modifying the tool may result in hazardous laser radiation exposure.



CAUTION! **CLASS 2 LASER PRODUCT**

- Never look into the laser beam directly and intentionally.
- Do not use optical tools to view the laser beam.
- Do not set up the tool at a position where the laser beam can cross any person at head height.
- Do not let children come in contact with the laser.

Item Checklist

Please ensure the following items are included with your laser level.
If anything is missing please contact your retailer.



General
ML-3DR

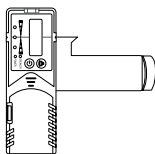

General ML-D3H
detector & clamp

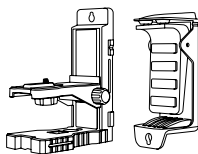

Multi-purpose
mount



Laser glasses
(red)



Laser target
(red)



Lithium-ion
battery pack (x2)



9V Alkaline battery
(detector)



AA Alkaline
batteries (x4)



Alkaline
battery pack

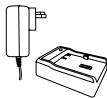

Indoor charger &
charging adaptor plate

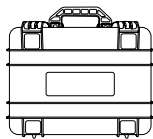

Hard carry case

ML-3DR KIT

Using the Laser

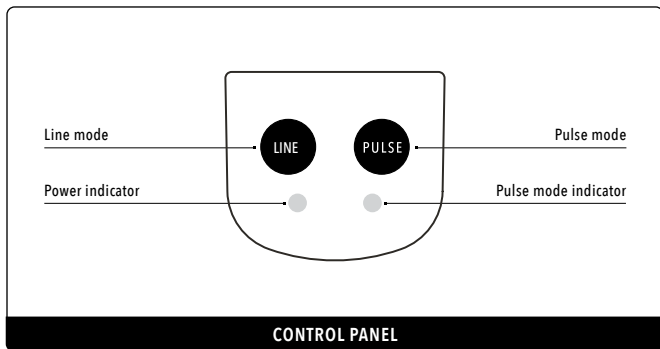
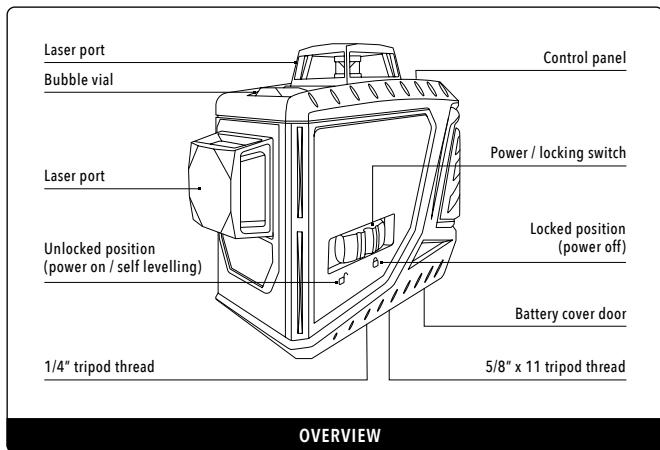

Using the Laser (continued)

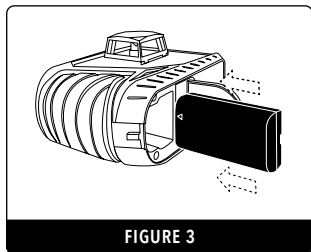
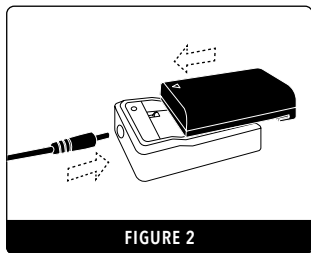
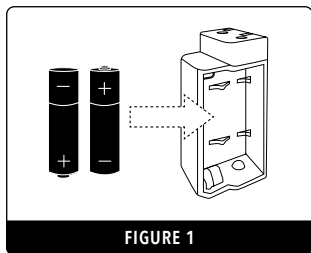

POWER SUPPLY

- The instrument is supplied with two li-ion battery packs. Only one battery pack is required to operate.
- The instrument is also supplied with four AA alkaline batteries as an alternative power source.

Inserting or replacing the alkaline batteries

- Insert the alkaline batteries into the battery tray according to polarity. (Fig. 1)
- Open the battery cover door and insert the battery tray.
- Close the battery cover door.

Charging the li-ion battery pack

- Insert the charger into the charging adaptor. Connect the li-ion battery onto the charging adaptor. Plug the charger into a power source. (Fig.2)
- Progress will be shown by the power indicator display on the charging adaptor as below:

 Red (flashing) = Charger and battery are not connected.

 Red (constant) = Battery is charging

 Green (constant) = Battery is charged

- Charging time is approximately 3-4 hours for a depleted battery.

Inserting & removing the li-ion battery pack

- Open the battery cover door and insert the battery tray (Fig.3)
- Insert the li-ion battery pack and close the battery cover door.

Using the Laser (continued)

SETUP

- Select a place as close as practical to the work site. Ensure the location is clear of traffic.
- Place the laser on a level surface such as a bench or supplied mount.

OPERATION

Powering on (self-levelling)

- To turn the instrument on, slide the power / locking switch to the "unlocked" position (Fig.4). Self levelling will commence and the horizontal beam will activate (Fig.5).
- Press the line mode button on the control panel to cycle through the active beams (Fig.6).
- If the instrument is outside the self levelling range the instrument will not level causing the laser beam to flash on and off repeatedly. If this occurs, reposition the instrument onto a level surface until the instrument can level off.

Powering off (self-levelling)

- To turn the instrument off, slide the power / locking switch to the "locked" position.

Tilt lock function (manual mode)

- Ensure the power / locking switch is in the "locked" position.
- Press and hold the line mode button for 3 seconds. The horizontal line will activate.
- The instrument can now be tilted to the desired angle.
- Press the line mode button on the control panel to cycle through the active beams.
- To turn off the beams, press the line mode button until all beams are off.

i When in tilt lock function (manual mode) the instrument will not self level and correct for vibrations and/or disturbances.

i Active laser beams will flash every four seconds when in manual mode.

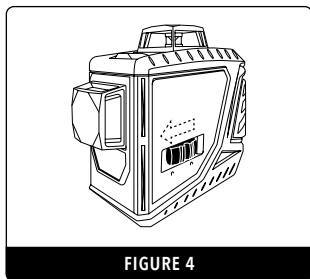

FIGURE 4

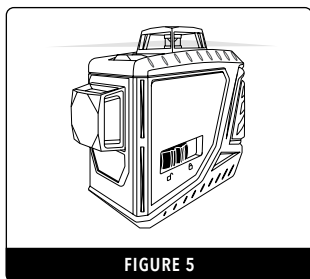

FIGURE 5

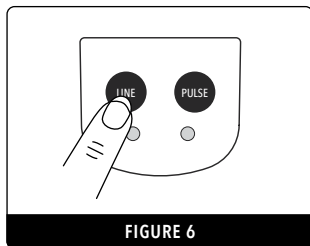
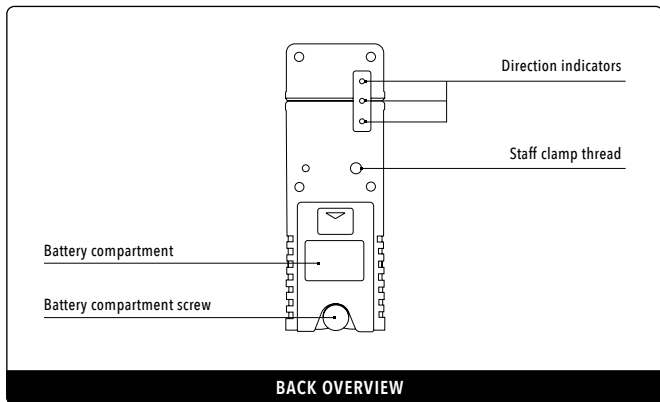
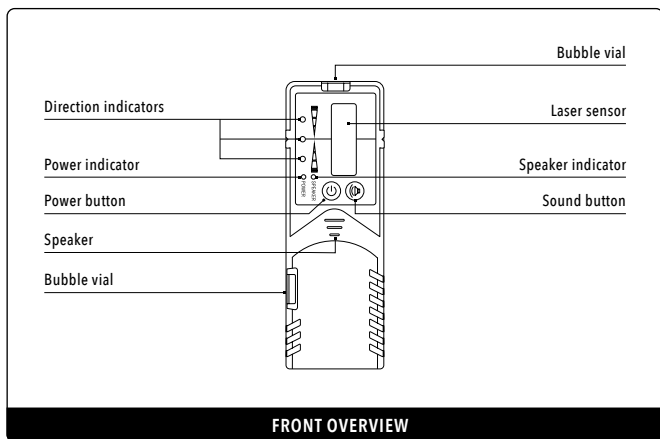

FIGURE 6

Using the Detector



Using the Detector (continued)

POWER SUPPLY

- The instrument is supplied with one 9V alkaline battery as its standard power source.

Removing & inserting the alkaline battery

- Open the battery cover door.
- Insert the alkaline battery into the battery tray according to polarity.
- Close the battery cover door.

SET UP

Mounting the staff clamp

- Insert the staff clamp screw into the staff clamp thread.
- Rotate the thumb screw until the clamp is secured in place.

OPERATION

Powering on

- Switch the detector on by pressing the power button. The speaker will emit a small tone to indicate the instrument is operating.

Speaker function

- Press the speaker button to turn the speaker off / on.

Operation with a multi-line laser level

- Press the pulse mode button on the laser level to enter into pulse mode. The pulse mode indicator LED will light up.
- Move the detector into the path of the laser beam.

- Hold the detector upright for horizontal beams (Fig.7) or rotate 90° for vertical beams (Fig. 8).
- The LED direction indicators will indicate the position of the laser beam. The centre LED will indicate alignment with the beam.

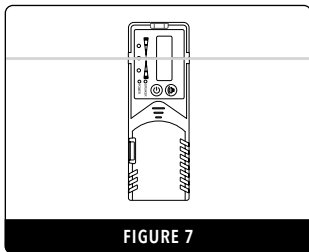

FIGURE 7

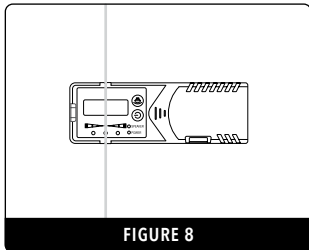
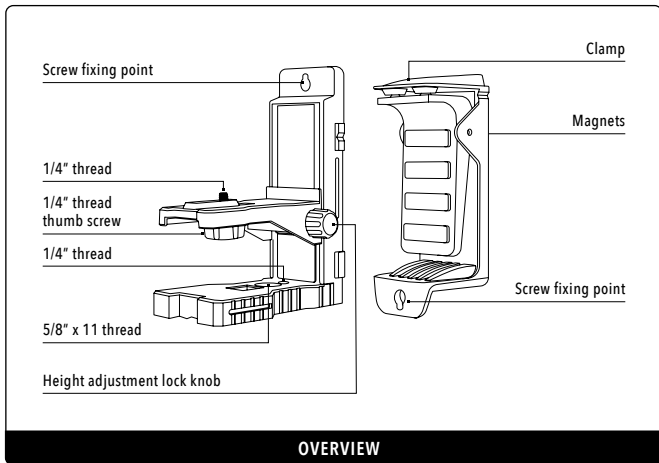

FIGURE 8

Using the Multi-purpose Mount



OVERVIEW

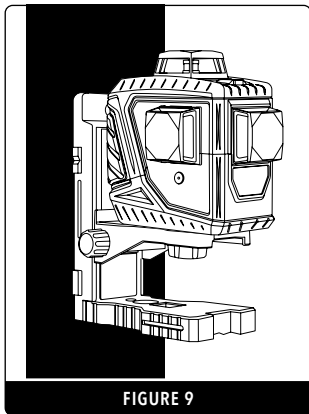
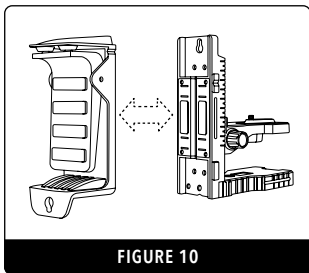

FIGURE 9

Mounting onto a magnetic surface

- Attach the instrument to the mount using the thumb screw.
- Attach the mount to a metal surface, ensuring that the mount has a strong hold before releasing your hands (Fig.9).
- To adjust the height of the instrument, unlock the height adjustment knob. Rotate the height adjustment knob to raise or lower the instrument to the desired height. Retighten the height adjustment lock knob to secure in place.
- To rotate the instrument on the mount, loosen the mini thumb screw, position the instrument, and then re-tighten the thumb screw.

Using the Multi-purpose Mount (continued)



Mounting via the clamp

- Attach the two mount pieces together via the magnetic backing (Fig.10).
- Attach the instrument to the mount using the thumb screw.
- Use the clamp to mount to a suspended ceiling track, ensuring that the mount has a strong hold before releasing your hands.
- To adjust the height of the instrument, unlock the height adjustment knob. Rotate the height adjustment knob to raise or lower the instrument to the desired height. Retighten the height adjustment lock knob to secure in place. Alternatively, slide the mount on the magnetic backing.
- To rotate the instrument on the mount, loosen the mini thumb screw, position the instrument, and then re-tighten the thumb screw.

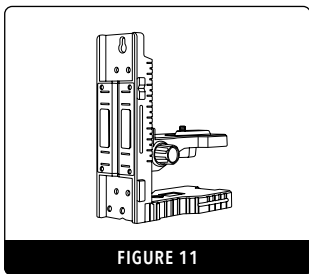

Mounting via screw fixing points - Method 1

- Using the single magnetic mount piece (Fig.11), attach the instrument to the mount using the thumb screw.
- Fix a screw into a secure surface and hook the mount over the screw. Ensuring that the mount has a strong hold before releasing your hands.
- To adjust the height of the instrument, unlock the height adjustment knob. Rotate the height adjustment knob to raise or lower the instrument to the desired height. Retighten the height adjustment lock knob to secure in place.
- To rotate the instrument on the mount, loosen the mini thumb screw, position the instrument, and then re-tighten the thumb screw.

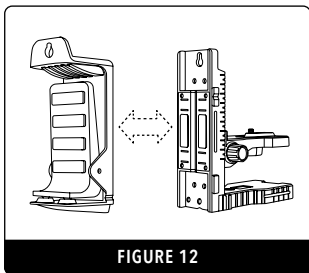

Mounting via screw fixing points - Method 2

- Attach the two mount pieces together with the screw hole at the top (Fig.12) and follow the instructions for method 1.
- This method allows the magnetic piece to slide up and down for added height adjustment flexibility.

Using the Tripod

NOT INCLUDED



A tripod can be purchased from your nearest measurement tool dealer. The below instructions are generic only and set-up methods may vary between models. Refer to the documentation from the tripod manufacturer for details.

- Extend the tripod legs to the required height and ensure the legs are spread wide enough so that the tripod platform is stable. Secure the legs in place (refer to the documentation from the tripod manufacturer for details).
- Place the laser level onto the tripod and mount via the male thread (5/8" or 1/4") into the base until firm. Do not over tighten as this may cause damage to the laser level or tripod.

NOTE: adjustment methods will vary on tripod models. Always ensure that any locking levers are unlocked before making adjustments and returned to the locked position when the adjustment is complete.

If using an elevating tripod with a measuring scale on the centre column, the height can be adjusted as required.



WARNING! Attaching the laser to a tripod without the correct thread size may cause damage.

Care & Maintenance

1. This is a precision measuring tool and should always be handled with care and transported within the carry pouch provided.
2. Always turn the tool off when transporting the laser level or moving around the job site.
3. Whenever possible, store the tool in a dry, shady location.
4. When the tool is not in use or is being stored, it is highly recommended to remove the batteries.
5. Calibration of the tool is recommended every six months, if ongoing accurate levelling is required, or an impact has occurred.
6. The operator should check the accuracy of the tool before precision levelling is attempted. Failure to do so may result in inaccurate measurements.
7. Clean the tool with a dry, soft cloth after use in dusty, damp or wet conditions before storing.
8. Smudges and fingerprints may be removed with a damp tissue or a soft, lint-free cloth.

Trouble Shooting

ERROR / PROBLEM	CAUSE / SOLUTION
Laser level does not power on	<ul style="list-style-type: none">• Check that the battery is charged.• Check the battery compartment for signs of damage and ensure that the compartment and battery terminals are clean.
Laser level does not remain on for long periods of use	<ul style="list-style-type: none">• Check that the battery is charged.• Check the battery compartment for signs of damage and ensure that the compartment and battery terminals are clean.
Laser level does not level in the unlocked self-levelling mode	<ul style="list-style-type: none">• The laser level may be outside of its self-levelling range and may require an adjustment before self-levelling can commence.• The laser level may have impact damage and may require repairs to become operational.
Detector does not detect the laser beam	<ul style="list-style-type: none">• Check that the laser level is powered on.• Check that pulse mode on the laser level has been activated.• Check the detector battery. The battery may require replacing.
I am seeing multiple lines on the same wall / surface area in parallel to one another	<ul style="list-style-type: none">• Check that no highly reflective surfaces are on the opposite side of the laser level (e.g., glass). Reposition the laser level to another area or block the laser beam from reflecting off the reflective surface.• If the lines are not in parallel you are seeing a diffraction line from the laser level. This is common due the design optics of 3D laser levels.

If the above troubleshooting steps do not resolve any issue that you may have, please contact 24-hour support.

Warranty

This tool comes with a standard 3 year warranty. Extend the warranty of your laser level to 7 years by registering online. See website for terms and conditions.

www.spoton.com.au/warranty-information

All Spot-on measurement tools are carefully checked and tested to our precise quality assurance standards. We offer a warranty in accordance with the following conditions:

1. Our warranty provides the correction of deficiencies to the tool once verified by an authorised service centre that the deficiencies were caused by a manufacturing fault within the warranty period.
2. The warranty period is 3 years from the date of purchase. The warranty period can be extended to 7 years upon registration of the tool within 30 days of purchase.
3. The warranty does not cover:
 - a) Calibrations and components that are subject to wear and tear.
 - b) Defects in the tool caused by non-compliance with the operation instructions, improper use, abnormal environmental conditions, inappropriate operating conditions or insufficient maintenance.
 - c) Defects caused by using accessories or spare parts other than approved parts.
 - d) Services or repairs carried out by non-authorised persons.
4. Defects recognised by an authorised service centre as being covered by the warranty shall be corrected either by repair or replacement of the tool.
5. The warranty claim must be lodged within the warranty period. This requires the complete tool with the original sales receipt containing the purchase date and place of purchase. Partial or disassembled tools cannot be submitted for a warranty claim.
6. Services provided under warranty do not lengthen or renew the warranty of the tool.

"Our goods come with guarantees that cannot be excluded under the Australian Consumer Law. You are entitled to a replacement or refund for a major failure and for compensation for any other reasonably foreseeable loss or damage. You are also entitled to have the goods repaired or replaced if the goods fail to be of acceptable quality and the failure does not amount to a major failure."

For more information please visit consumerlaw.gov.au

Specifications

SPECIFICATIONS	ML-3DR
Product code	GML3DRPRMKT
Warranty	7 Years (with online registration)
Accuracy	±1.5mm at 10m
Operating range	60m (with included detector)
Levelling range	±4°
Laser class	2 Red
Battery life	10 hours +
Battery type	Li-ion battery pack / 4x 1.5V AA
Vertical lines	2
Horizontal lines	1
IP rating	54
Weight (kg)	0.8
Dimensions (mm)	150 x 75 x 125

Customer Support

To assist you with any queries or technical questions please contact customer support.

1300 658 338

Visit www.spoton.com.au for more information.



Spot-on Laser & Tool Company Pty Ltd

Spot-on Laser & Tool Company Pty Ltd reserves the right to make changes to specifications and product descriptions at any time. © Spot-on Laser & Tool Company Pty Ltd. 2021. Printed in China.