

Lasertec

CX2G

CROSSLINE LASER



I N S T R U C T I O N M A N U A L

SAFETY

Read the following safety instructions before attempting to operate this product.

Keep these instructions in a safe place or store in the carry case for future reference.

SAVE ALL WARNINGS AND INSTRUCTIONS FOR FUTURE REFERENCE.

 **WARNING: Read and understand all instructions.**

- Use the laser only with the specifically designated batteries.
- Store the laser out of reach of children and other untrained persons. Lasers are dangerous in the hands of untrained users.
- Use only accessories that are recommended for your model.
- Tool service must be performed only by qualified repair personnel. Repairs, service or maintenance performed by unqualified personnel will void the warranty. Only approved and authorised service technicians can carry out warranty repairs.
- Do not use optical tools such as a telescope or transit to view the laser beam. Serious eye injury could result.
- Do not place the laser in a position which may cause anyone to intentionally or unintentionally stare into the laser beam. Serious eye injury could result.
- Do not position the laser near a reflective surface which may reflect the laser beam toward anyone's eyes. Serious eye injury could result.
- Do not use optical tools to view the laser beam.

SAFETY (continued)

- Do not set up the tool at a position where the laser beam can cross any person at head height.
- Do not let children come in contact with the laser.
- Turn the laser off when it is not in use. Leaving the laser on increases the risk of staring into the laser beam.
- Do not operate the laser around children or allow children to operate the laser. Serious eye injury may result.
- Do not remove or deface warning labels.
- Position the laser securely on a level surface. Damage to the laser or serious injury could result if the laser falls.

 **WARNING: Do Not Disassemble The Laser.**

There are no user serviceable parts inside. Disassembling the laser will void all warranties on the product. Do not modify the product in any way. Modifying the tool may result in hazardous laser radiation exposure.

CAUTION: Class 2 Laser Product

- Never look into the laser beam directly and intentionally.
- Do not use optical tools to view the laser beam.
- Do not set up the tool at a position where the laser beam can cross any person at head height.
- Do not let children come in contact with the laser.

ITEM CHECKLIST

Please ensure the following items are included with your laser level.
If anything is missing please contact your retailer.

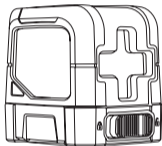

Lasertec CX2G

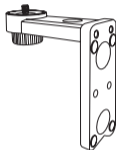

Magnetic mount



Laser target



AA alkaline batteries



Carry pouch

LASER OVERVIEW

Control panel

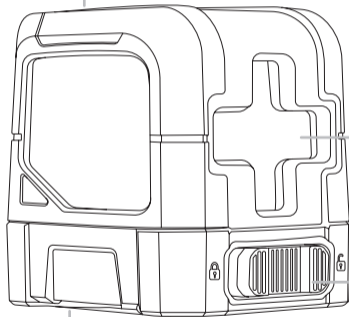

Laser port

Locking switch

Battery door cover

1/4" tripod thread

LASER OVERVIEW: CONTROL PANEL

- Power
- Pulse mode (*press and hold for 3 seconds*)



MAGNETIC MOUNT OVERVIEW

1/4" thread

1/4" thumb screw

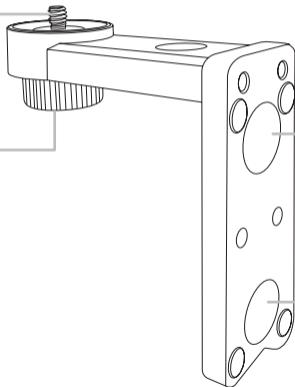

Magnet

Magnet

USING YOUR LASER

POWER SUPPLY

- The instrument is powered by two AA alkaline batteries.

Battery Replacement

- Remove the *battery cover door* and the batteries.
- Insert the batteries according to polarity and replace the *battery cover door*.

SET UP

- Select a place as close as practical to the work site. Ensure the location is clear of traffic.
- Place the instrument on a level surface such as a bench or mount.
- To mount the instrument onto the supplied magnetic mount, follow the instructions on page 11.

OPERATION

Powering on (self levelling)

- To turn the instrument on, slide the *locking switch* to the “*unlocked*” position. Self levelling will commence and all beams will activate.
- If the instrument is outside the self levelling range the instrument will not level causing the laser beam to flash on and off repeatedly. If this occurs, reposition the instrument onto a level surface until the instrument can level off.

Powering off

- To turn the instrument off, slide the *locking switch* to the “*locked*” position.
 - Press the *power* button for 1 second.
-  Always slide the *locking switch* to the “*locked*” position when transporting the instrument or moving around the job site.

USING YOUR LASER *(continued)*

Tilt lock function (manual mode)

- Ensure the **locking switch** is in the “**locked**” position.
- Press the **power** button to activate the laser beams.
- The instrument can now be tilted to the desired angle. The beams will flash approximately every 5 seconds to alert the user that the instrument is in manual mode.

i When in tilt lock function (manual mode) the instrument will **not** self level and correct for vibrations and/or disturbances.

i Pulse mode cannot be enabled whilst the instrument is in manual mode.

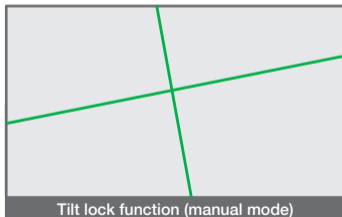

USING YOUR LASER (continued)

USING THE MAGNETIC MOUNT

Mounting onto a magnetic surface

- Attach the instrument to the mount using the *thumb screw*.
- Attach the mount to a metal surface, ensuring that the mount has a strong hold before releasing your hands.
- To rotate the instrument on the mount, loosen the *thumb screw*, position the instrument, and then re-tighten the *thumb screw*.

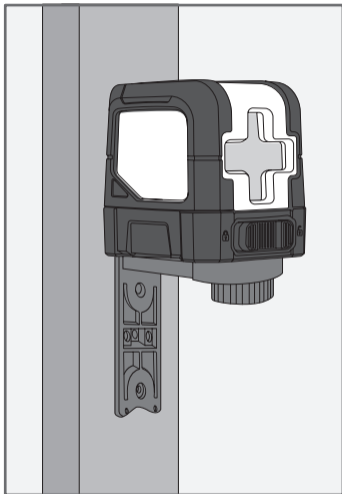

USING YOUR LASER (continued)

USING AN OPTIONAL DETECTOR

- Press and hold the **power** button for 3 seconds to enter into **pulse mode**. The laser beam will flash 3 times to indicate that pulse mode is active.
- Switch the detector on by pressing the **power button**. The **speaker** will beep indicating the instrument is operating.
- Move the detector into the path of the laser beam.
- Hold the detector upright for horizontal beams. Rotate the detector 90° for vertical beams.
- The **LED direction indicators** will indicate the position of the laser beam. The **centre LED** will indicate alignment with the beam.

i The detector is an optional accessory which can be purchased from your retailer.

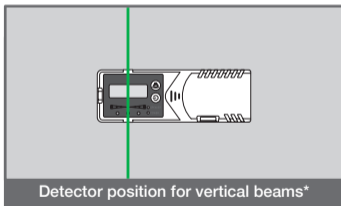
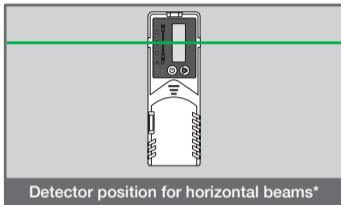

* Detector image shown is for illustrative purposes only. Actual model may vary.

TROUBLE SHOOTING

Error	Cause & Solution
Laser does not turn on	<ul style="list-style-type: none">• Check the batteries. They may be in the wrong way or need replacing.• Check the battery compartment for signs of damage. Ensure they are clean and not bent.
Laser does not remain on for long periods of use.	<ul style="list-style-type: none">• Check the batteries.• Check the battery compartment for signs of damage. Ensure they are clean and not bent.
Laser does not level off	<ul style="list-style-type: none">• Instrument may be outside its self levelling range. Adjust the instrument or tripod so it is level.• Instrument may have impact damage.

CARE AND MAINTENANCE

- This is a precision measuring instrument and should always be handled with care and transported within the carry pouch provided.
- Always slide the *locking switch* to the “*locked*” position when transporting the instrument or moving around the job site.
- Whenever possible, store the instrument in a dry, shady location.
- Calibration of the instrument is recommended: every six months, if ongoing accurate levelling is required, or an impact has occurred.
- The operator should check the accuracy of the instrument before precision levelling is attempted. Failure to do so may result in inaccurate measurements.
- Clean the instrument with a dry, soft cloth after use in dusty, damp or wet conditions before storing.
- Smudges and fingerprints may be removed with a damp tissue or a soft, lint-free cloth.

WARRANTY

3 YEAR STANDARD WARRANTY

1. The warranty period for your tool is 3 years from the date of purchase.
2. The warranty period for batteries, battery packs and chargers is 1 year from the date of purchase.
3. Calibrations are not covered under warranty as they are deemed wear and tear.
4. All products have a standard warranty period, you do not have to register your products to obtain the standard warranty period.
5. To claim under this warranty, the date of purchase of the tool must be documented by an invoice/receipt.

7 YEAR EXTENDED WARRANTY

1. The extended warranty is available on selected tools only.
2. You may extend the warranty period for your tool to 7 years from the date of purchase. This excludes batteries, battery packs and chargers.
3. Calibrations are not covered under warranty as they are deemed wear and tear.
4. To obtain the extended warranty, the registration process must be completed within 30 days from the date of purchase.
5. Failure to register your product online and/or submission of a valid invoice/receipt will void the warranty extension.
6. Please ensure ALL information submitted/uploaded is correct.W
7. Extended warranty is ONLY available via online registration, offline (mailing in of warranty registration) will not be accepted.

WARRANTY *(continued)*

AUSTRALIA

“Our goods come with guarantees that cannot be excluded under the Australian Consumer Law. You are entitled to a replacement or refund for a major failure and for compensation for any other reasonably foreseeable loss or damage. You are also entitled to have the goods repaired or replaced if the goods fail to be of acceptable quality and the failure does not amount to a major failure.”

For more information please visit
consumerlaw.gov.au

NEW ZEALAND

For more information please visit
consumerprotection.govt.nz

CUSTOMER SUPPORT

To assist you with any queries or technical questions please contact customer support

Australia: 1300 658 338

New Zealand: 0800 367 527

United Kingdom: 0808 189 1152

SPECIFICATIONS

CX2G			
Product code	91135	Battery type	2x 1.5v AA
Warranty	7 Years*	Vertical lines	1
Accuracy	±2mm at 10m	Horizontal lines	1
Operating range	40m (with optional detector)	IP rating	54
Levelling range	±4°	Weight (kg)	0.26 (inc. batteries)
Laser class	2 Green	Dimensions (mm)	75 x 65 x 75
Battery life	10 hours		

*With online registration (3 years without registration). Please refer to page 15 for details.



www.spoton.com.au